

FILTRO - IVR 995 L - IVR 98



Filtro inox con raccordo in nylon (IVR 995L)
- in ottone (IVR 98)

Stainless steel mesh filter with nylon connection (IVR 995L) - with brass connection (IVR 98)

Filtre inox avec raccord en nylon (IVR 995L)
- en laiton (IVR 98)

*NirostahlfILTER mit nylon-gewinde (IVR 995L)
- mit messing-gewinde (IVR 98)*



IVR 995L



IVR 98

IVR 98

DN	3/8"	1/2"	3/4"	1"	1*1/4	1*1/2	2"	2*1/2	3"	4"
H	47	54	60	64	72	82	95	96	112	127

Dimensioni in mm - Dimensions in mm

IVR 995L

DN	1/2"	3/4"	1"	1*1/4	1*1/2	2"	2*1/2	3"	4"
H	57	57	59	67	78	88	97	106	119

Dimensioni in mm - Dimensions in mm

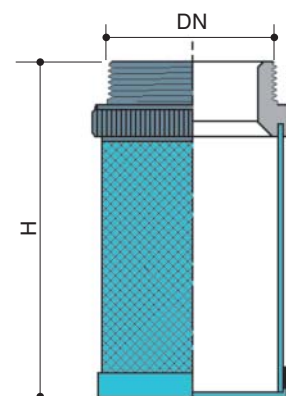

RITEGNO CON FILTRO - IVR 923



Valvola di ritegno con filtro inox incorporato.

Check valve with filter connected.

Clapet de retenue avec filtre incorporé.

Rückschlagventil mit Saugkorb.

N. N.	DENOMINAZIONE PART NAME	MATERIALE MATERIAL	TRATTAMENTO TREATMENT
1	Corpo - Body	Ottone - Brass CW 617N - UNI-EN 12165/98	
2	Filtro - Filter	Acciaio inox AISI 304 Stainless steel AISI 304	
3	Molla - Spring	Acciaio inox AISI 302 Stainless steel AISI 302	
4	Otturatore - Disc	Copolimero di Acetale Acetal copolymer	
5	Guarnizione - Gasket	NBR	

DN	1/2"	3/4"	1"	1*1/4	1*1/2	2"	2*1/2	3"	4"
F	10	10	14	14	14	16	19	19	21
L	32	39	46	56	69	84	103	112	139
H	80	87	95	107	124	140	160	172	194

Dimensioni in mm - Dimensions in mm

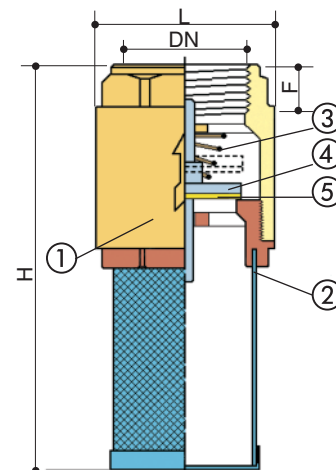

DATI TECNICI - TECHNICAL DATA

Pressione di esercizio Working pressure	1/4" - 1" 1*1/4 - 2"	16 bar 10 bar
Temperatura di esercizio Working temperature	0 °C + 90 °C	
Filettatura estremità Threaded ends	UNI ISO 228/1	