



INOX - IVR 655



 Valvola di ritegno in acciaio inox AISI 316 - attacchi F/F

 Stainless steel AISI 316 vertical check valve - threaded ends F/F

 Rückschlagventil aus Edelstahl AISI 316 - IG/IG

 Vanne de retenue en acier inox AISI 316 - fixations F/F

 Вертикальный обратный клапан из нержавеющей стали AISI 316 - Соединения В/В

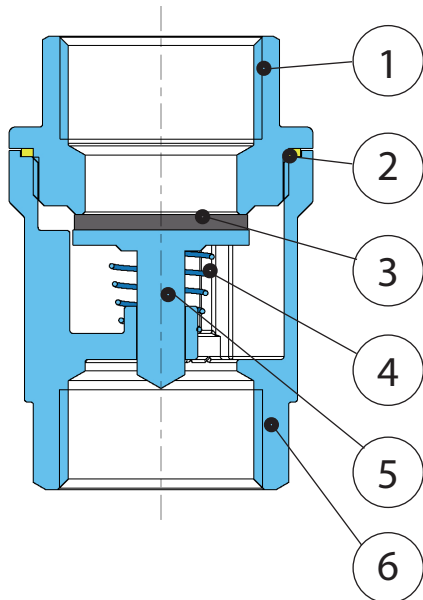

Size 
1/4"-4" 64 bar

Estremità filettate
UNI ISO 228/1

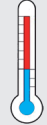
 Max +180° C
Min -25° C

N	DENOMINAZIONE PART NAME	MATERIALE MATERIAL	TRATTAMENTO TREATMENT
1	Corpo - Body	Acciaio inox AISI 316 Stainless steel AISI 316	
2	Guarnizione - Gasket	PTFE	
3	Guarnizione - Gasket	FKM	
4	Molla - Spring	Acciaio inox AISI 316 Stainless steel AISI 316	
5	Otturatore - Disc	Acciaio inox AISI 316 Stainless steel AISI 316	
6	Corpo - Body	Acciaio inox AISI 316 Stainless steel AISI 316	

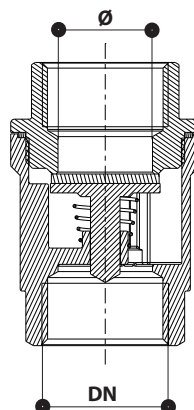
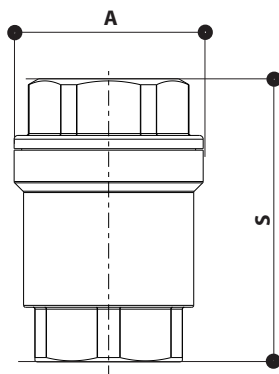

DN	Ø	S	A
1/4"	8	53	30.5
3/8"	10	53	30.5
1/2"	15	56	37.5
3/4"	20	63	42
1"	25	74	48
1"1/4	30	81	58
1"1/2	38	91	70
2"	47	97	82
2"1/2	61	118	102.5
3"	75	138	120
4"	94	158	150

DIMENSIONI - DIMENSIONS (mm)

Tutte le caratteristiche tecniche dei prodotti sono soggette a modifiche senza preavviso - All product's technical specifications are subject to modification without prior notice